

## Teemärgised

### 1. Teekattemärgised

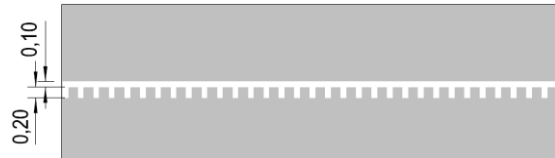

911



911a



912



913



914



915



916



917



921

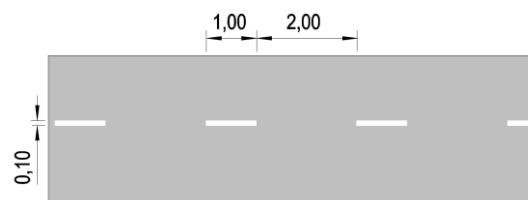

921a



922

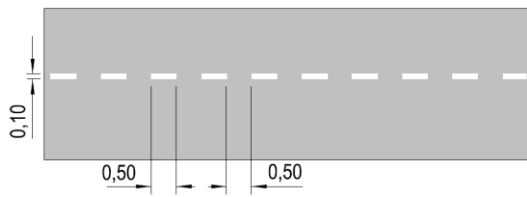

923a

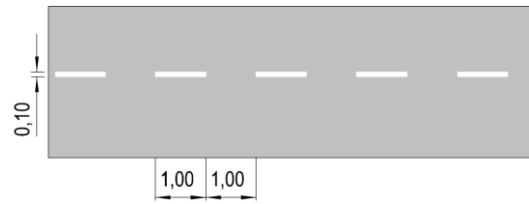

923b

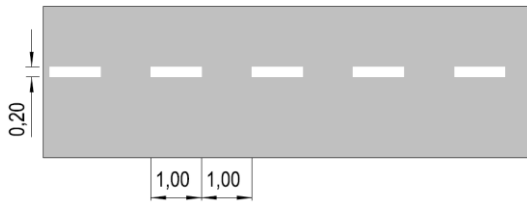

923c

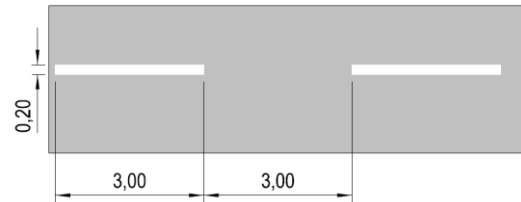

923d

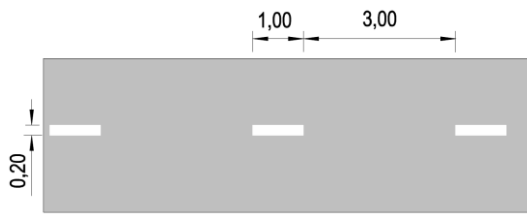

924

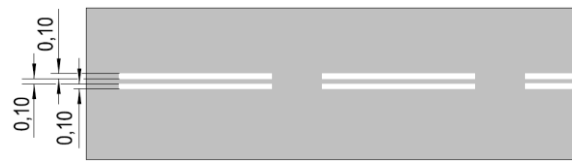

925



931

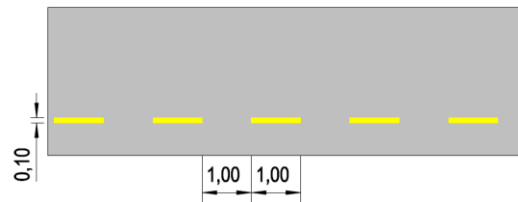

932

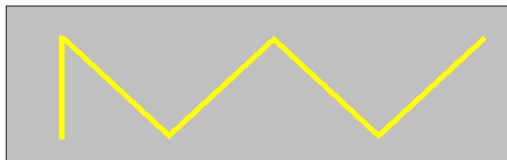

933

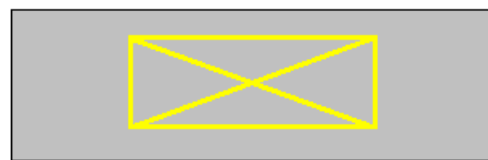

934



941



942

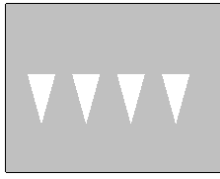

943

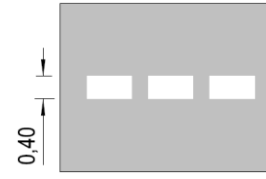

943a

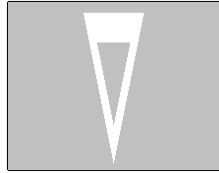

944

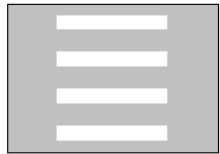

945a

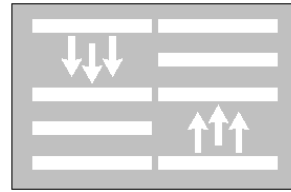

945b



946a



946b



946c



946d



947



948



949a

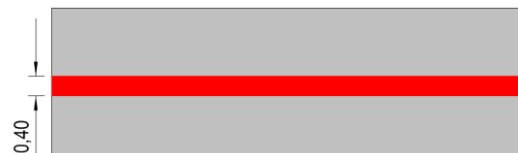

949b



949c



949d



951 952 953 954 955 956 957a 957b 958a 958b 959

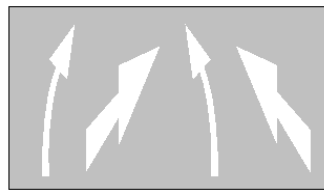

961 961a 962 962a



971a

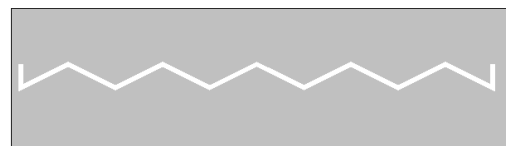

971b



972



973



974



975



976

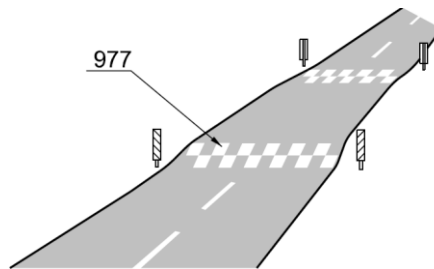

977



978

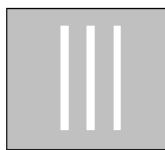

979a



979b

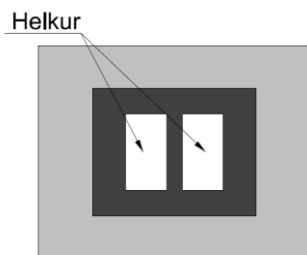

981a

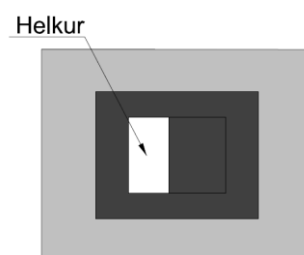

981b

## 2. Püstmärgised



991v



991k



992v



992k

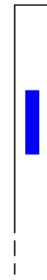

992s

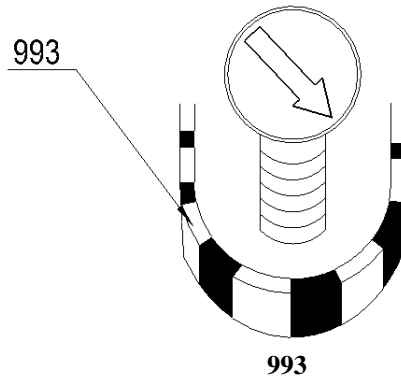

993

Majandus- ja kommunikatsiooniministri  
22. veebruari 2011.a. määruse nr 12  
„Liiklusmärkide ja teemärgiste  
tähtendus ja nõuded fooridele“ lisa 10

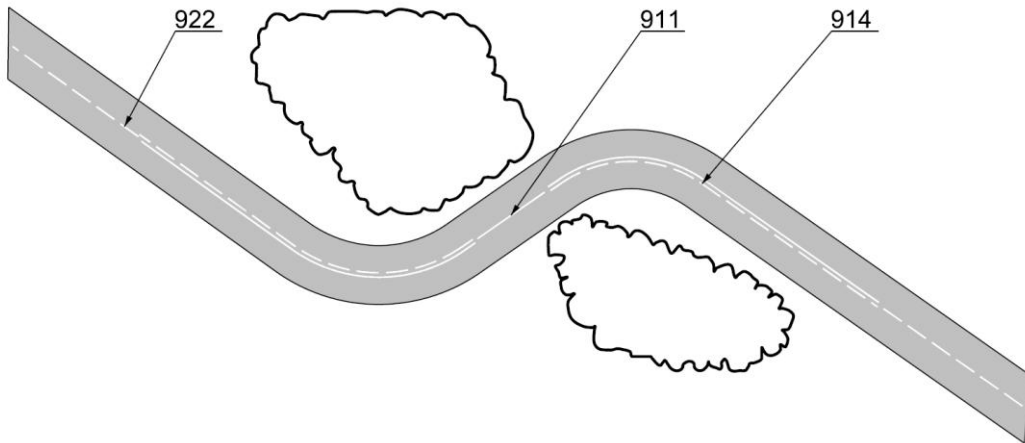

Joonis 1

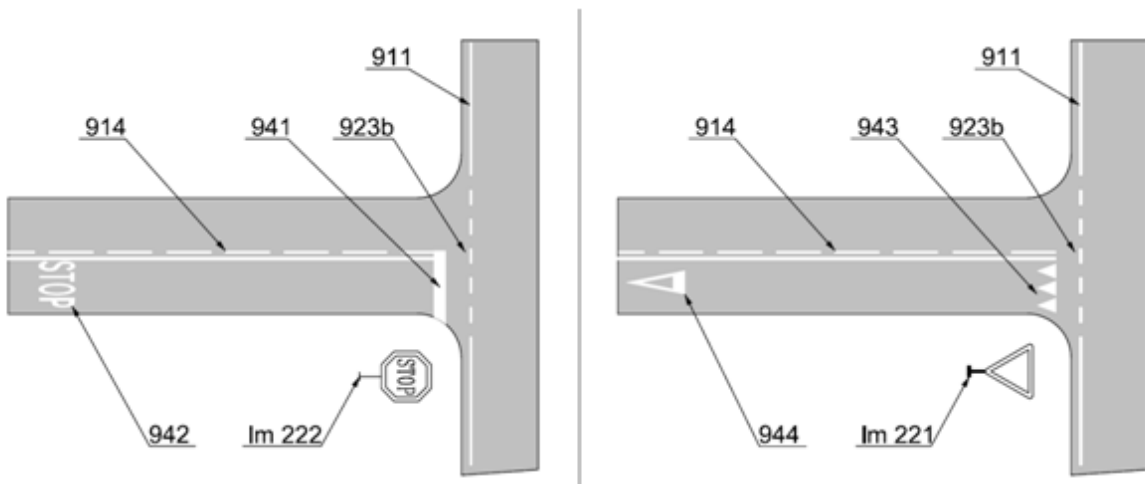

Joonis 2

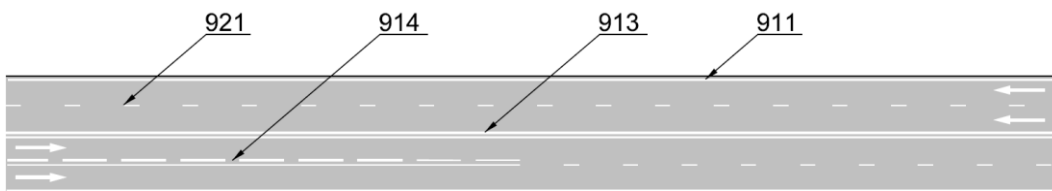

Joonis 3

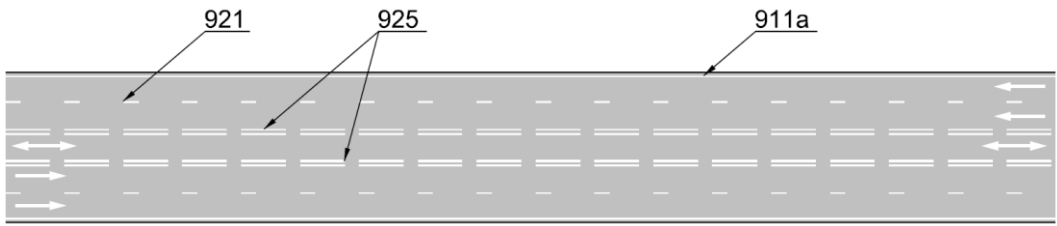

Joonis 4

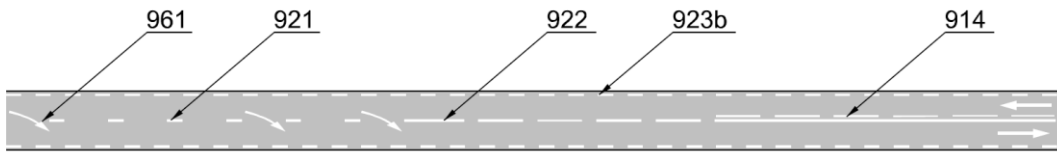

Joonis 5

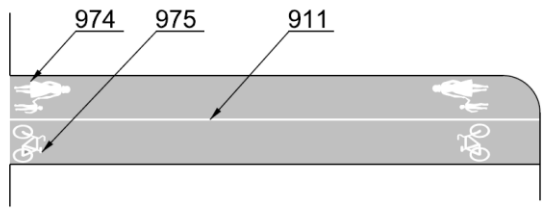

Joonis 6

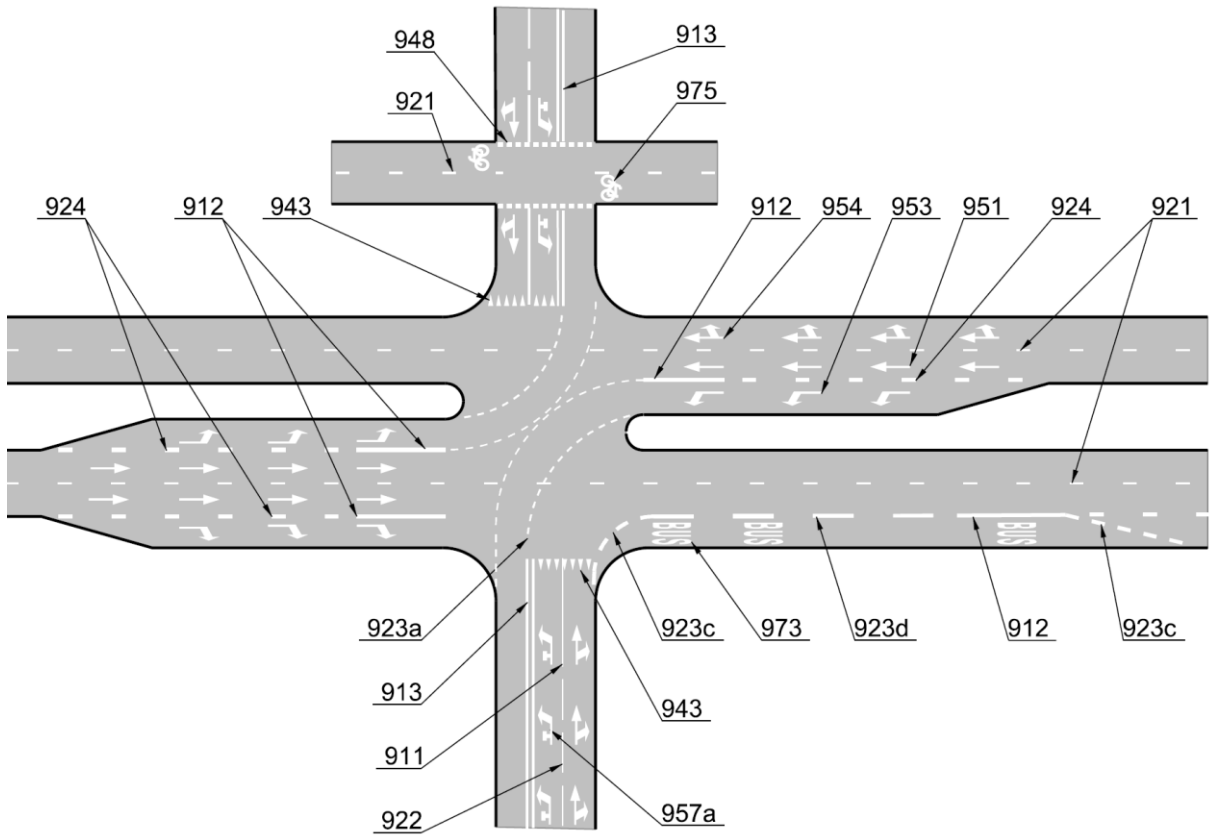

Joonis 7



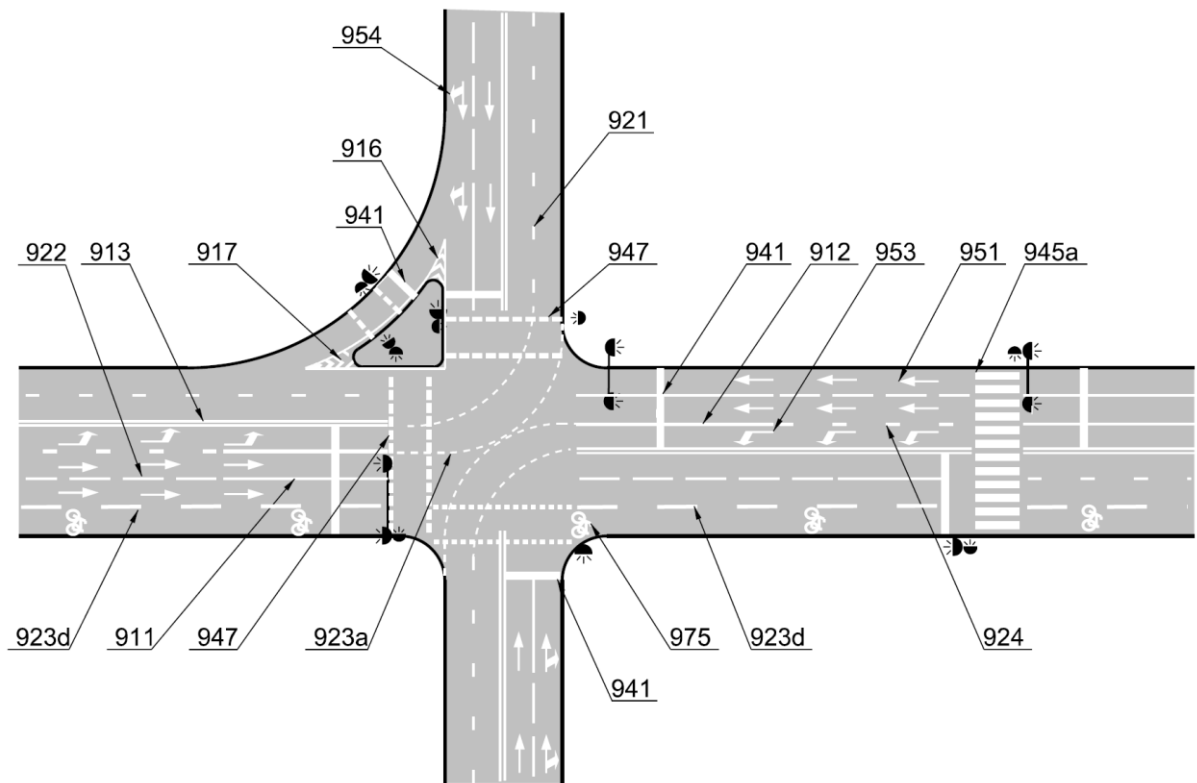

Joonis 8

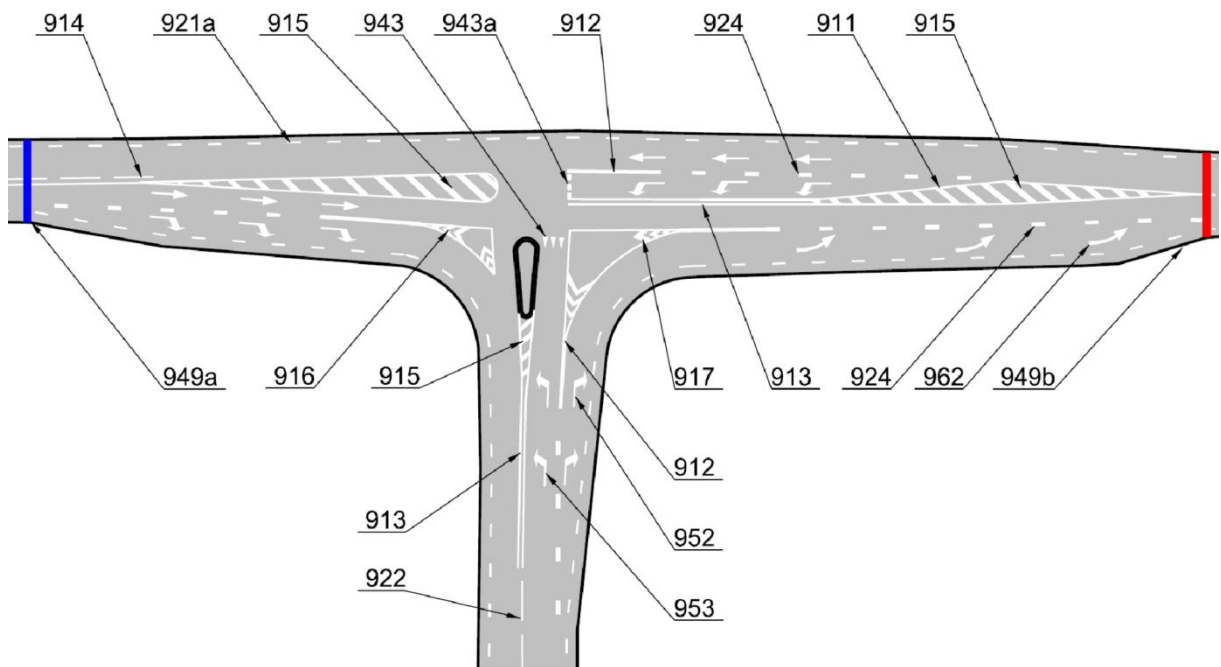

Joonis 9

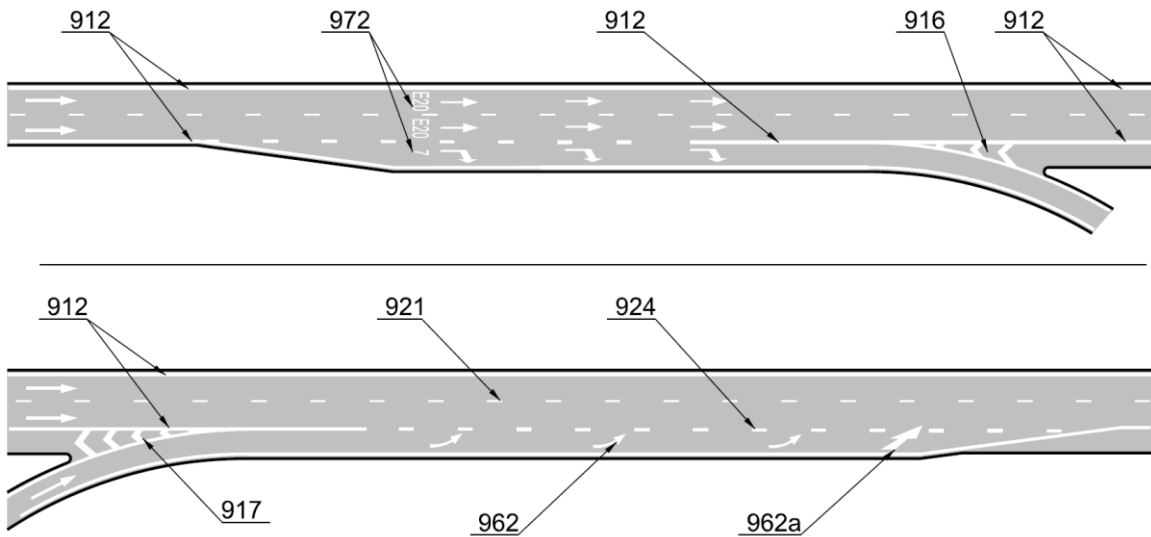

Joonis 10

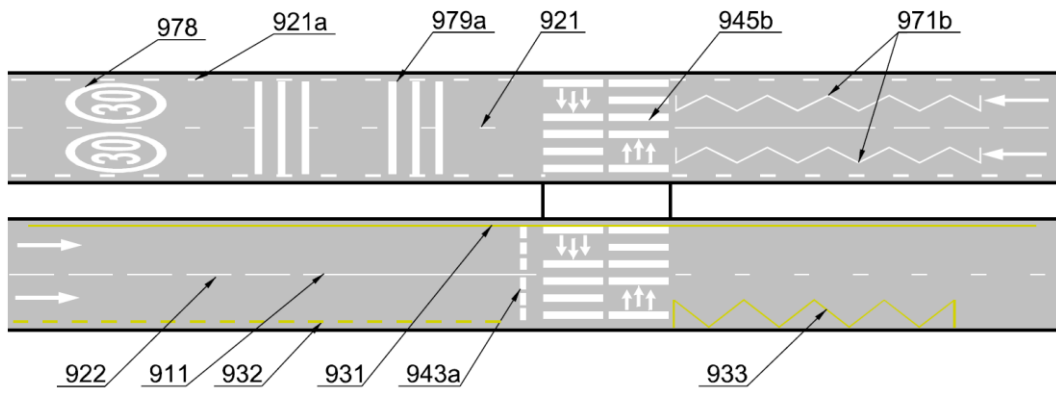

Joonis 11

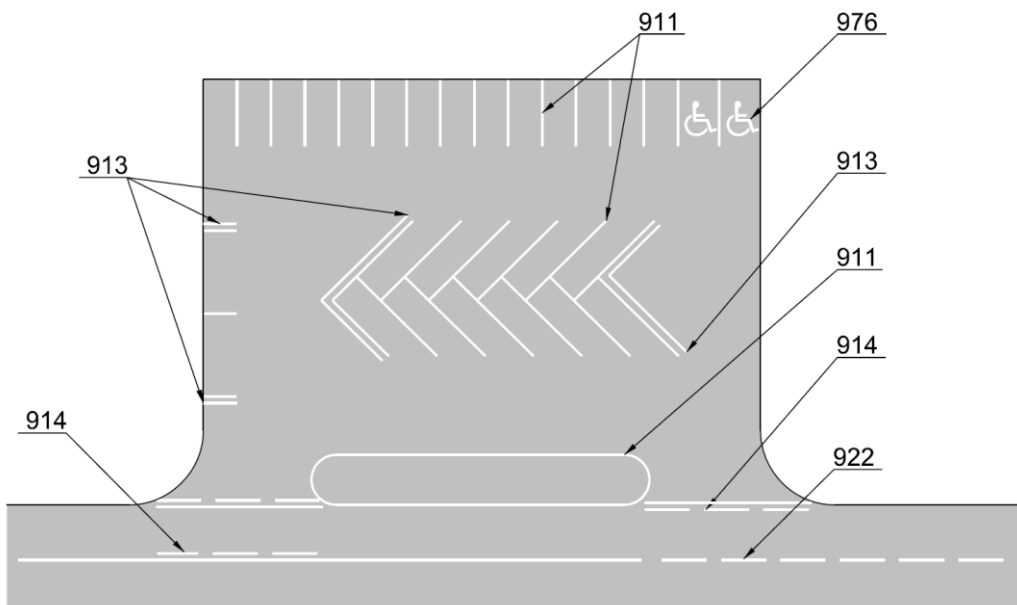

Joonis 12